

RPZ211V120

Ballast Type: Electronic
 Input Voltage: 120Vac ±10%
 Input Frequency: 47-63Hz

Starting Method: Preheat Rapid Start
 Lamp Connection: Series

Unit Color: Galvanneal
 Unit Weight: 0.33 lbs.

ELECTRICAL SPECIFICATIONS:

Line Voltage (V)	No. of Lamps	Lamp Type	Typical Lamp Watts (W)	Lamp Voltage (V)	Lamp Current (mA)	Input Current (A)	Input Power (W)	Input Current THD (%)	Lamp Current Crest Factor	Electrical Efficiency
108	2	Actinic BL PL-S 9W	9	50	178	0.31	18.6	121	1.48	0.93
120				48	210	0.32	21.2	125	1.51	0.91
132				46	240	0.33	23.9	127	1.53	0.91
108	2	TUV PL-S 9W/4P	9	50	178	0.31	18.6	121	1.48	0.93
120				48	210	0.32	21.2	125	1.51	0.91
132				46	240	0.33	23.9	127	1.53	0.91
108	2	HNS S 9 W G23 (GCF9DS/G23/SE/OF)	9	50	178	0.31	18.6	121	1.48	0.93
120				48	210	0.32	21.2	125	1.51	0.91
132				46	240	0.33	23.9	127	1.53	0.91
108	2	HNS S/E 9W 2G7	9	53	152	0.30	17.6	124	1.45	0.88
120				51	186	0.31	20.2	128	1.49	0.89
132				48	213	0.33	23.1	130	1.53	0.86
108	2	HNS S 11 W G23 (GCF11DS/G23/SE/OF)	11	78	150	0.41	25.1	102	1.50	0.93
120				76	175	0.42	28.4	108	1.51	0.93
132				71	206	0.42	31.2	113	1.48	0.95
108	2	HNS S/E 11W 2G7	11	83	112	0.38	23.6	108	1.42	0.84
120				82	146	0.39	26.7	112	1.43	0.85
132				79	170	0.40	29.5	117	1.43	0.86

PERFORMANCE:

- Power Factor = >0.50
- Encased & Potted
- Sound Rated A
- Internal Surge Protection
- Meets FCC Part 18 (Class B) for EMI and RFI Consumer Limits
- Meets ANSI Standard C62.41 for Transient Protection
- Meets ANSI Standard C82.11 for Ballast Requirements

APPLICATION:

- Maximum Case Temperature: 167°F/75°C
- Maximum Ambient Temperature: 122°F/50°C
- Minimum Starting Temperature: 23°F/-5°C
- Remote Mounting: 18 ft. Max. Lead Length, 18AWG

SAFETY/STANDARDS:

- UL/935 Listed (Class P, Type 1 Outdoor)
- cUL (CSA/C22.2 Certified)
- No PCBs, Type HL, Type CC
- Inherent Thermal Protection
- RoHS Compliant

CASE STYLE: CS-3C

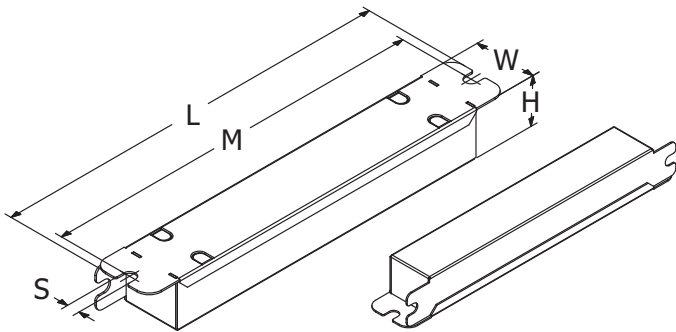

L	W	H	M	S
5-29/32	7/8	3/4	5-5/8	3/16
5.91	0.91	0.75	5.63	0.19
15.00 cm	2.30 cm	1.91 cm	14.29 cm	0.48 cm

WIRING DIAGRAM: WD-116 (4-PIN LAMPS)



WIRING DIAGRAM: WD-116B (2-PIN LAMPS)



- Black: 12"
- White: 12"
- Tolerance: +1.00, -0.50"
- Strip: 0.375" ± 0.060"

- Red: (2) 12"
- Blue: (2) 12"
- Yellow: (2) 12"
- Tolerance: +1.00, -0.50"
- Strip: 0.375" ± 0.060"

WARRANTY:

Robertson Worldwide warrants to the purchaser that this product will be free from defects in material or workmanship for a period of 3 years from date of manufacture when properly installed and under normal condition of use. Specifications subject to change without notice.

For more information on Robertson Worldwide products, visit www.RobertsonLighting.com